





# T SERIES

## CONDUIT BODIES



### INCLUDES:

-  x 2 cover screws
-  set screws for EMT
-  x 1 neoprene gasket
-  x 1 stamped aluminum cover



### CONSTRUCTION

- Die cast aluminum combination fitting (EMT and rigid) available in 1/2", 3/4", 1", 1-1/4", 1-1/2", 1-3/4" and 2" sizes.
- Unit is threaded for rigid conduit and has set screws for EMT.
- Durable grey powder coat paint finish.

### FEATURES

- Product includes conduit body, black neoprene gasket, stamped aluminum cover with screws.

### APPLICATION:

-  Ideal for industrial or commercial use
-  Weather resistant

### CERTIFICATION:



DIMENSIONS

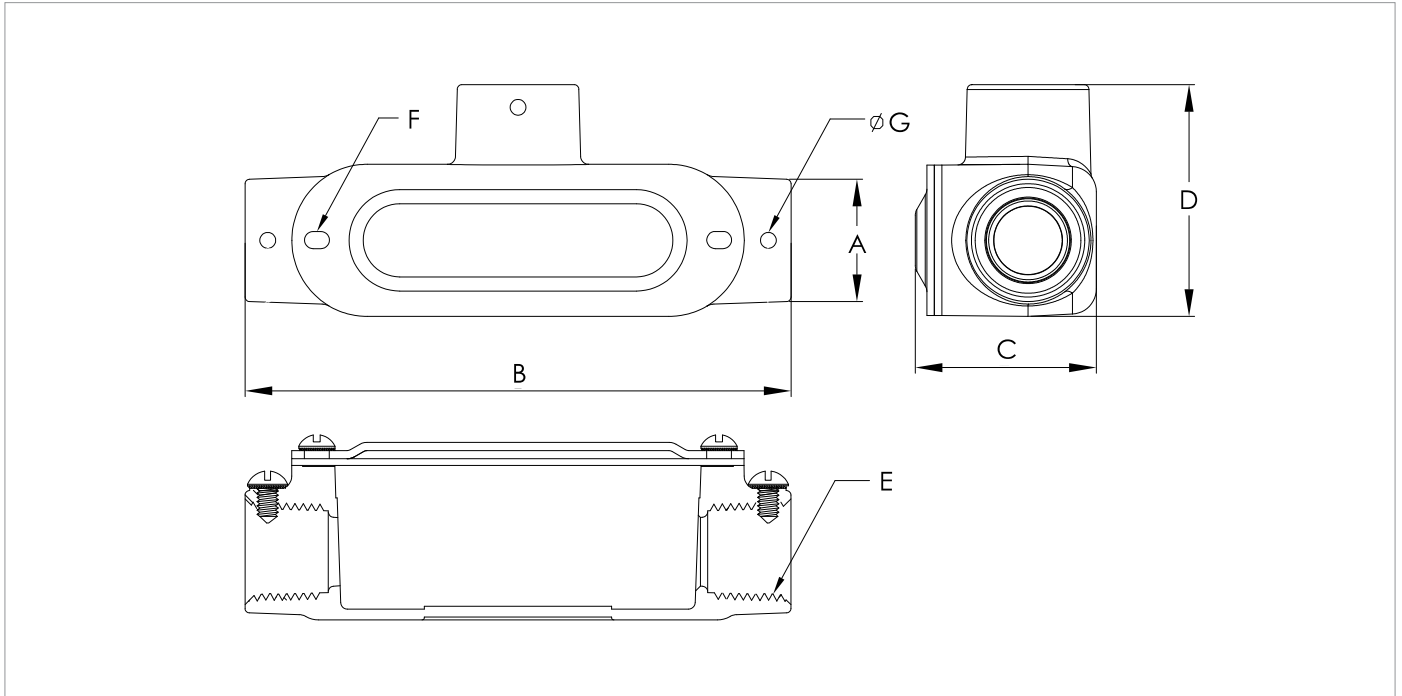

PRODUCT	A	B	C	D	E CONDUIT SIZE	F COVER SCREWS	G SET SCREWS
T-50-CG CONDUIT BODY	1.06	4.75	1.57	2.01	1/2"	2x8-32	2x10-24
T-75-CG CONDUIT BODY	1.31	5.61	1.81	2.27	3/4"	2x8-32	2x10-24
T-100-CG CONDUIT BODY	1.56	6.47	2.12	2.65	1"	2x8-32	2x10-24
T-125-CG CONDUIT BODY	2.00	8.11	2.77	3.42	1-1/4"	2x12-24	4x1/4-20
T-150-CG CONDUIT BODY	2.24	8.11	2.89	3.42	1-1/2"	2x12-24	4x1/4-20
T-200-CG CONDUIT BODY	2.70	10.54	3.58	4.20	2"	2x12-24	4x1/4-20

ORDER INFO

STOCK CODE / DESCRIPTION
008773 T-50-CG CONDUIT BODY
008774 T-75-CG CONDUIT BODY
008775 T-100-CG CONDUIT BODY
008776 T-125-CG CONDUIT BODY
008777 T-150-CG CONDUIT BODY
008778 T-200-CG CONDUIT BODY