

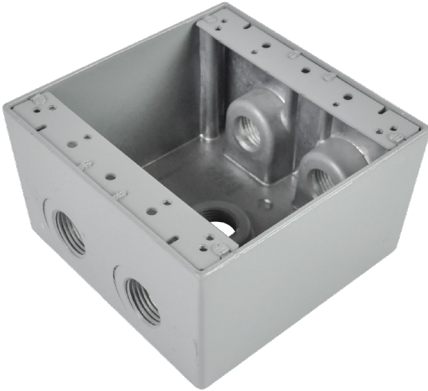



DDB252P

RECTANGULAR BOX



INCLUDES:

-  x 2 threaded plugs
-  x 2 galvanized steel mounting tabs
-  x 1 ground screw
-  x 2 screws



CONSTRUCTION

- 2 Gang die cast aluminum deep box with five 1/2" threaded entries.
- Durable silver grey powder coat paint finish.
- Stamped galvanized steel tabs for ease of mounting.

FEATURES

- Package includes box, 2 plugs, 2 galvanized steel mounting tabs, 2 screws and a ground screw.

APPLICATION:

-  Ideal for industrial or commercial use
-  Weather resistant

CERTIFICATION:



DIMENSIONS

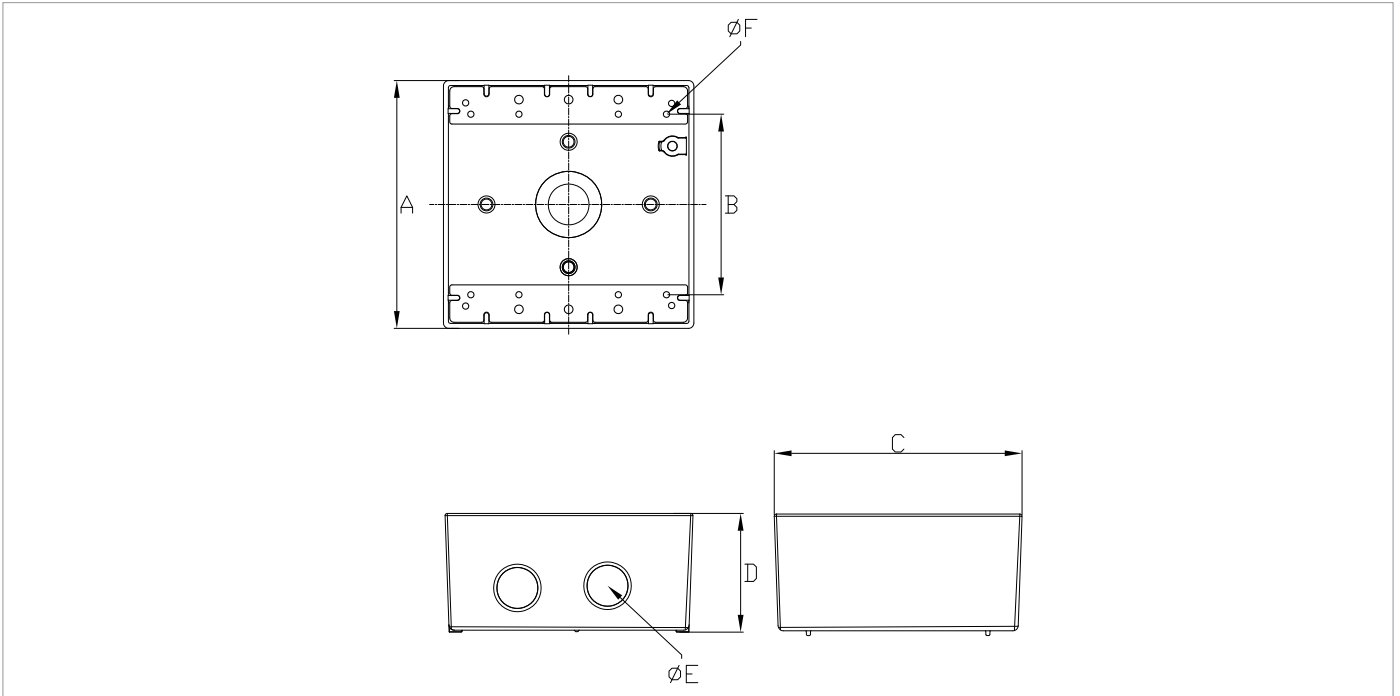

PRODUCT	A	B	C	D	E CONDUIT ENTRY	F SCREW HOLES
DDB252P	4.52	3.29	4.56	2.71	5x1/2 NPT	12x6-32

ORDER INFO

STOCK CODE / DESCRIPTION

095788 DDB252P - GREY DEEP BOX - 5 X 1/2" ENTRIES - 2