



UC120-LED

Under Cabinet Light

	12"	20"	40"	60"
Watts	3.67	8.38	15.92	21.47
Lumens	263	679	1,240	1,577
Efficacy (Lm/W)	71.6	81.0	77.9	73.3

SPECIFICATIONS

Colour Temp	4K, 3K
Certification	cULus, IP20, Energy Star
Operating Temp	-20°C to +40°C
Voltage	120V (Line Voltage)
LED Life	50,000 hours
Housing Material	Aluminum
Lens Material	Polycarbonate
Accessories	90°, Straight Interconnect, Interconnect cables, 5' Power cord with Plug (with or without On/Off Switch), Wiring Compartment
Compatible Dimmers	COOPER DAL06P COOPER D106P Pass&Seymour HCL453PW
Dimming Range	100% to 2%



All Sizes:

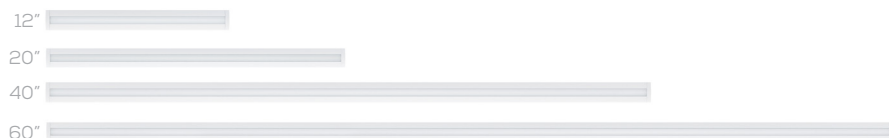

DESCRIPTION

The UC120-LED under cabinet light fixtures have direct 120V AC dimmable driver eliminating the need for an external power source. These fixtures are easy to install and can be used in plugin installations.

APPLICATIONS



Cove Lighting



Kitchen Cabinet



Task Lighting



Closets



Offices

FEATURES

- Line voltage under cabinet fixture with built in 120V dimming driver.
- Extruded aluminum housing with frosted lens in white finish.
- Available in lengths of 12", 20", 40" and 60".
- Available in 3,000K or 4,000K.
- 400W maximum on one run.

POLAR PLOT

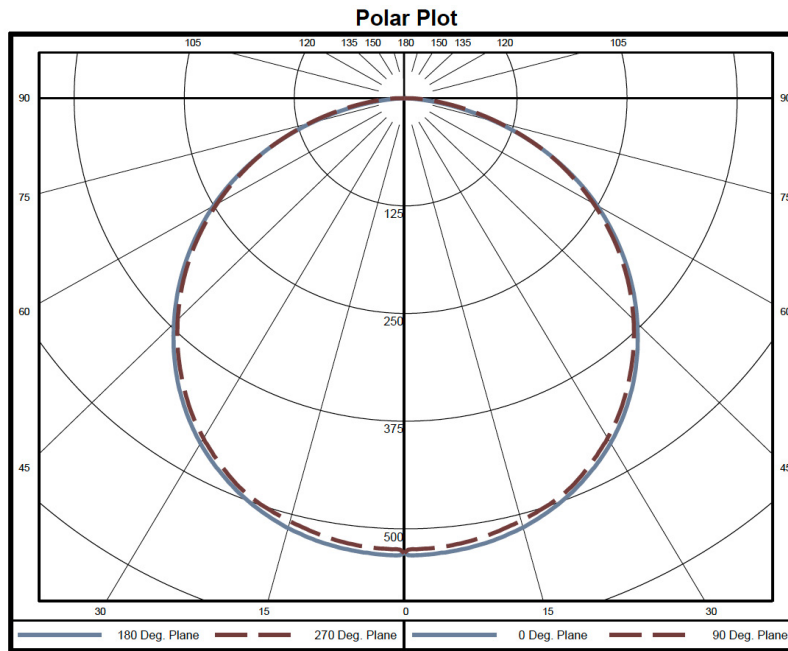

HARDWIRE OPTION (SOLD SEPARATELY)

WIRING COMPARTMENT

The UC120 Wiring Compartment allows direct wiring connections when installing UC120-LED series under cabinet lights instead of using a plug-in option.

- Connect up to 400W per run.
- Entries are for use with NMD90 14AWG and 3/8" cable clamp.
- Interconnect cable to connect multiple compartments is available.
- The compartment can be opened from the top for easy access.
- Can be mounted under a cabinet with four screws.
- The box has four entries to suit any wiring option.

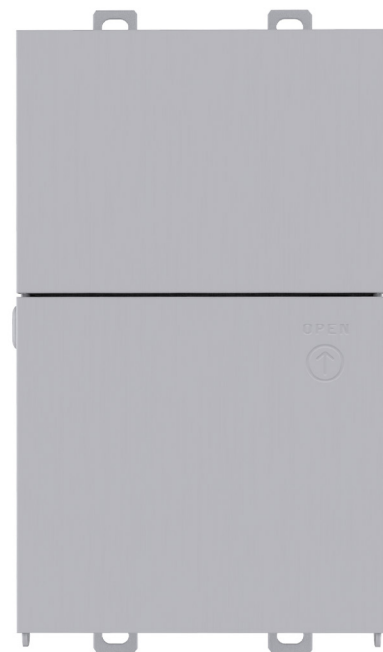

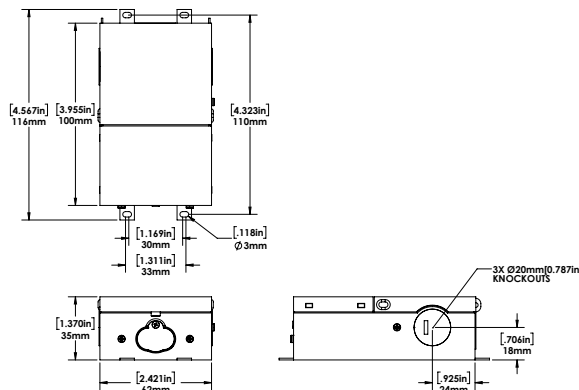

DIMENSIONS:





ACCESSORIES (SOLD SEPARATELY)

We offer a wide range of accessories to facilitate plugin or hardwired installations.

INTERCONNECT

	<p>STRAIGHT INTERCONNECT - (INCLUDED IN EVERY BOX) The straight interconnect connects fixtures and accessories in a single run.</p>
	<p>90° INTERCONNECT The 90° interconnect directly connects fixtures and accessories around a corner.</p>
	<p>INTERCONNECT CABLE Available in various lengths, the interconnect cable connects fixtures and accessories in a single run.</p> <p>AVAILABLE IN: 6" 12" 24" 36"</p>

POWER CORDS

	<p>5' POWER CORD WITH PLUG 5' power cord with plug allows fixtures to directly connect to a power source.</p>
	<p>5' POWER CORD WITH PLUG AND ON/OFF SWITCH 5' power cord with plug and on/off switch allows you to turn lights on/off through the switch on the power cord.</p>

DIMENSIONS

UC120-LED12

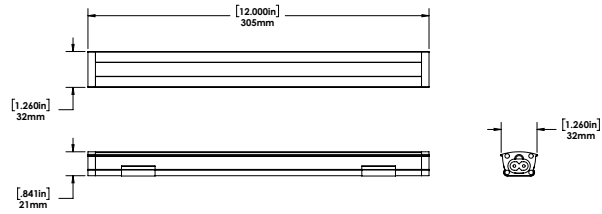

UC120-LED 20

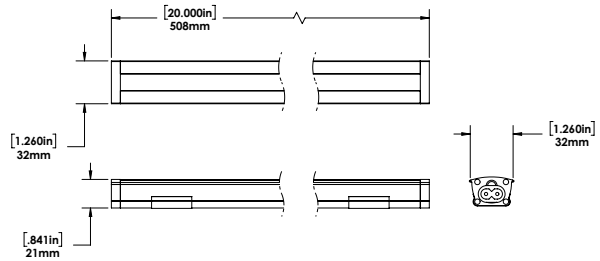

UC120-LED 40

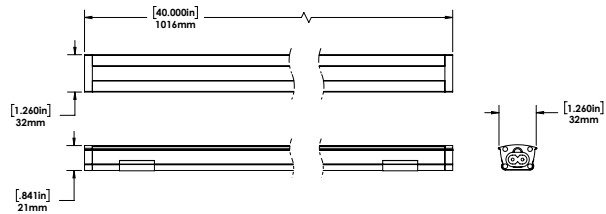

UC120-LED 60

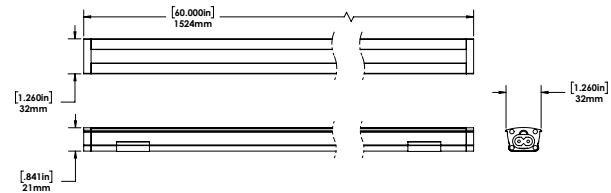

90° INTERCONNECT

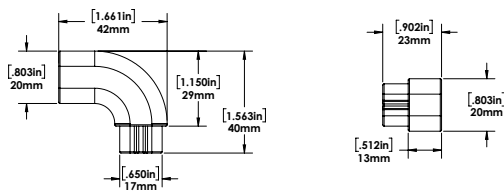

STRAIGHT INTERCONNECT



5' POWER CORD WITH PLUG

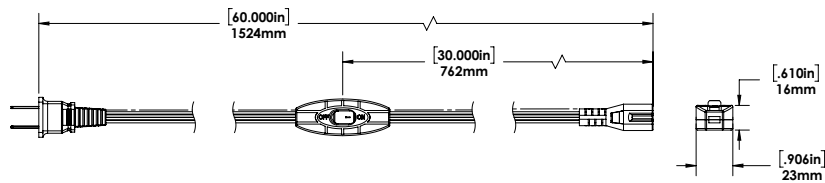

MODEL SPECIFICATIONS

MODEL DESCRIPTION	VOLTAGE (V)	INPUT POWER (W)	LIGHT OUTPUT	EFFICACY (Lm/W)	PF
UC120-LED12	120	3.67	263	71.6	0.980
UC120-LED20	120	8.38	679	81.0	0.973
UC120-LED40	120	15.92	1240	77.9	0.993
UC120-LED60	120	21.47	1577	73.3	0.995

ORDERING GUIDE

UC120	LENGTH	COLOUR TEMP.
	LED12 - 12"	NW - 4000K
	LED20 - 20"	WW - 3000K
	LED40 - 40"	
	LED60 - 60"	

FIELD INSTALLED ACCESSORIES:

CHECK THE ACCESSORIES YOU WISH TO ORDER:



90° Interconnect - 089992



5' Power Cord with Plug - 089998



5' Power Cord with Plug and On/Off Switch - 089999



Interconnect Cable:

- 6" Cable - 089994
- 12" Cable - 089995
- 24" Cable - 089996
- 36" Cable - 089997



Wiring Compartment - 092929